

# Veth Rudder Propellers

**THE POWER** 360°  
TO TURN YOUR WORLD

**VETH**  
PROPULSION

## About Veth Propulsion

Veth Propulsion is a customer-oriented Dutch thruster manufacturer. A family-owned company, established in Papendrecht in the Netherlands in 1951, and international player which is leading in quality, service, innovation and sustainability.

Veth Propulsion develops and produces various types of Z-drives, including retractable thrusters, Hybrid Drives, Swing Outs and deck mounted units. You can find the Veth Rudder propeller everywhere, from inland marine to tug and offshore vessels. The type of Z-drive that best suits your needs, depends on factors such as the type of vessel you have and the desired maneuverability. It revolves around what you consider to be important!

You can expect a personal and down-to-earth approach and a reliable image and brand awareness in several marine markets. Your sailing profile and specific needs form the basis for our bespoke solutions including rudder propellers, bow thrusters, diesel engines and generator sets.

Your requirements are our starting point to entering into a relationship. Due of the wide range of products, combined with the expertise of our staff and our innovative designs, you can always expect a total concept.

You can also choose to have the drive line delivered with your rudder propeller or thruster. As a leading Scania and Sisu Diesel dealer, Veth Propulsion delivers new and remanufactured propulsion engines (variable speed) and generator engines (set and variable speed).

Relying on our expertise and decades of experience, we can give you advice on the most suitable solution and possibilities. Please contact us for more information or visit our website.

## Lean Manufacturing

Lean Manufacturing is a process where maximum value is created for our customers by “working smarter,” resulting in higher product quality, lower production costs and faster turnaround. Veth Propulsion applies Lean Manufacturing in various ways to its business operations:

- Providing a high quality product coupled with solid inventory management
- Shorten lead time by tailoring the activities of various departments
- “Just in time delivery”, stock management and sufficient production capacity and resources
- Learning ability › anyone can contribute ideas to optimize processes and product quality
- Special attention for wasting of material, energy consumption, use of chemicals etc.
- 5S method › to establish the ideal workplace, with the aim of creating a pleasant and efficient work environment





Charlock | Type: VL-1800



TSHD Charlock

## Rudder propeller in general

The basic principle of a rudder propeller is simple and effective. The propeller rotates 360 degrees around its own vertical axis to guarantee maximum maneuverability in all directions.

Veth thrusters are suitable for a wide range of vessels, thanks to our flexibility and customization. Your wishes are the basis, with several possible options, configurations and drive lines to choose from.

Our azimuth thrusters are available in either Z- or L-drive configurations and can be powered by any power source; the control for its azimuth system can be either electric or hydraulic.

By stocking the standard parts for every one of our thrusters, we can provide fast service when needed.

The thruster units are available with open propeller, counter-rotating propellers or with a nozzle. The Veth Control Systems are developed in-house by our R & D department.

### Training Veth Propulsion 1

*(For more information, please visit our website)*

A nautical training programme from Veth Propulsion takes (at least) two days. You will learn to handle rudder propellers in theory as in practice. It is important that you experience the difference between manoeuvring with a conventional system and manoeuvring with azimuth thrusters. After theoretical instruction, you can put this knowledge into practice and operate the Veth Propulsion 1 azimuth thrusters yourself. You also have the opportunity to follow on-board complimentary training about:

- Technical operation and electrical control of azimuth thrusters
- Faults (diagnosis and resolution) / making an emergency stop
- Maintenance of an azimuth thruster

In short, an in-depth training that puts education and experience first.





Veth Propulsion delivers technically advanced innovations and always thinks alongside with us for the best solutions and high quality products.

Marc Overheul, New Building Manager Kotug International

**Power range single propeller Z-drives (VZ), L-drives (VL) and Hybrid Drives (VHD)**

Type	Max power (kW)	Propeller diameter nozzleed (mm)
VL-50	61	Ø450
VL-180	168	Ø700
VZ/VL-200	233	Ø900
VZ/VL-400	468	Ø1130
VZ/VL-400A	425	Ø1030
VZ/VL-550	555	Ø1250
VZ/VL-700	688	Ø1400
VZ/VL-900	968	Ø1600 - Ø1700
VZ/VL-1100	1305	Ø1800 - Ø1900
VZ/VL-1250	1425	Ø1900 - Ø2000 - Ø2100
VZ/VL-1550	1920	Ø2200 - Ø2300 - Ø2400
VZ/VL-1800	2350	Ø2400 - Ø2500 - Ø2600

**Advantages Z-drive (compared to a conventional propeller system)**

- 360 degrees full thrust, thus optimum maneuverability
- 2% more efficiency than with a conventional propeller
- Possibility for flexible suspension (better insulation from noise and vibration)
- Ability to change propeller without docking
- Simple to install in a variety of ways
- More room for passengers / cargo due to compact construction
- No separate gearbox needed
- Ideally suited for Dynamic Positioning (DP)
- Safer, through shorter emergency stopping distance and improved maneuverability



Type: VZ-900 (with VOB50 nozzle)

**Power range counter rotating Z-drives (VZ), L-drives (VL) and Hybrid Drives (VHD)**

Type	Max power (kW)	Propeller diameter nozzleed (mm)
VZ/VL-160-CR	139	Ø585 - Ø650
VZ/VL-450-CR	475	Ø1080 - Ø1200
VZ/VL-700-CR	674	Ø1210 - Ø1350
VZ/VL-900-CR	985	Ø1350 - Ø1500
VZ/VL-1250-CR	1390	Ø1530 - Ø1700

- The indicated values are based on full continuous operation and are subject to application and classification
- Z-drives are also available in Hybrid propulsion. Hybrid input power is available through consultation.
- Data is only to be used as a guideline. Additional specific data is available through Veth Propulsion.
- No rights can be taken from this sheet and data is subject to change without notice.

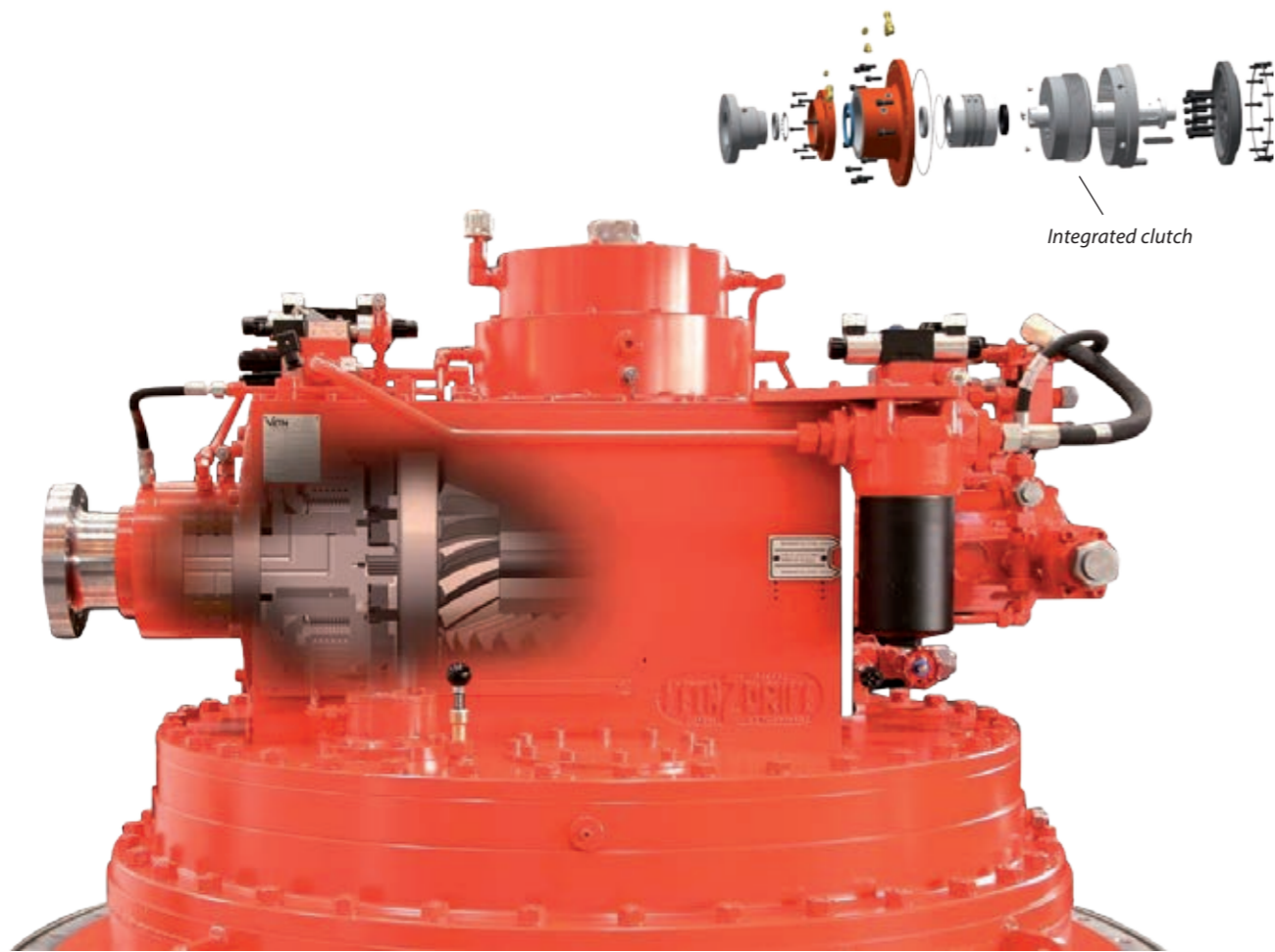

# Veth thruster fundamentals

The choices Veth Propulsion makes in the design and manufacture of its products, shows that they are inspired by the needs of the market and decades of engineering craftsmanship.

## Driven by simplicity

Veth Propulsion believes in the power of simplicity, combined with robustness and sustainability, which you will find reflected in all of its products. So there are few moving parts outside the gearbox, and all Veth thrusters are built with minimal piping due to its compact construction. The use of durable and high quality materials ensures a robust and reliable construction, for long life requiring little maintenance.

By designing and building all rudder propellers in three separate main components, mounted together by class approved connections, the Veth thrusters are robust, reliable and easily serviceable. In case of severe damage due to e.g. under water collision, the time to repair will be limited by these separations. This is significantly different in comparison with most other rudder propeller manufacturers which, in general, use larger cast iron parts for quick and easy assembly. Although this helps to bring down initial costs, it

is making servicing harder to carry out and damage, if any, more extensive.

What makes the Veth thruster unique is that it is custom made for your requirements. The foundation is always adapted to the shape of your ship's hull so that when the thruster is placed, it requires no further welding (unless a welded installation is specified).

- No fixed center-to-center distances. Your thruster will be completely tailor-made for your vessel.
- The freewheel clutch is integrated (optional) in the upper gearbox
- One supplier for your complete thruster which means short communication lines.
- Our thrusters are suitable for 100% continuous rated power.

## Limited slipping clutch

Veth Propulsion offers an integrated slipping clutch solution as an option. This slipping clutch enables the operator the ability to manoeuvre the vessel with absolute accuracy.

The hydraulically actuated clutch, which functions as a conventional clutch by default, can convert idle engine rpm to much lower propeller shaft rpm values (typical 100 rpm-600 rpm). The ability to do so is achieved by a controlled slipping mode in the wet clutch plates.

The clutch is a robust design and incorporated in the upper gearbox. This feature is also completely self-sufficient, with regard to cooling and controlling. The electrohydraulic control system is completely integrated into the Veth Propulsion control system.

The advantage of the integration of both control systems is that all the information necessary to control the thruster is directly available without the intervention of third party systems. This provides you with a safe and accurate control.

The stroke of the lever is divided into a slipping section and a regular throttle section, which is an advantage to accurately control the slipping section of the clutch. This makes limited slipping clutch just as easy to control as the full range of propeller speeds. This is included as an optional feature in the Veth standard: robust, easy to operate and maintenance friendly.

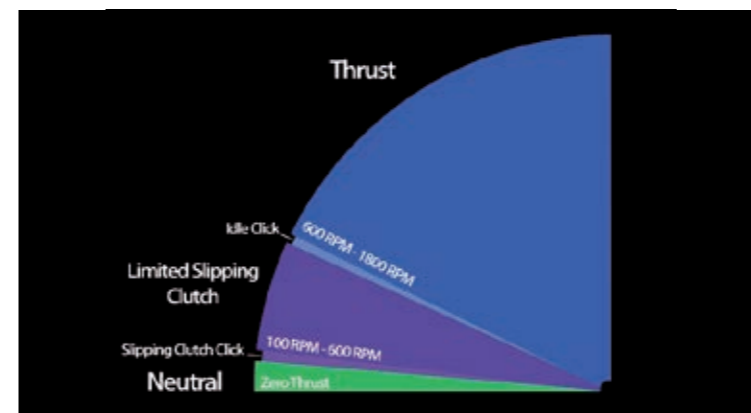

*These indicated values are subject to application. Please consult us for the possibilities.*



Prince Job 1 | Engine room



Prince Job 1



Bolted connection of lower gearbox to the middle part of the thruster

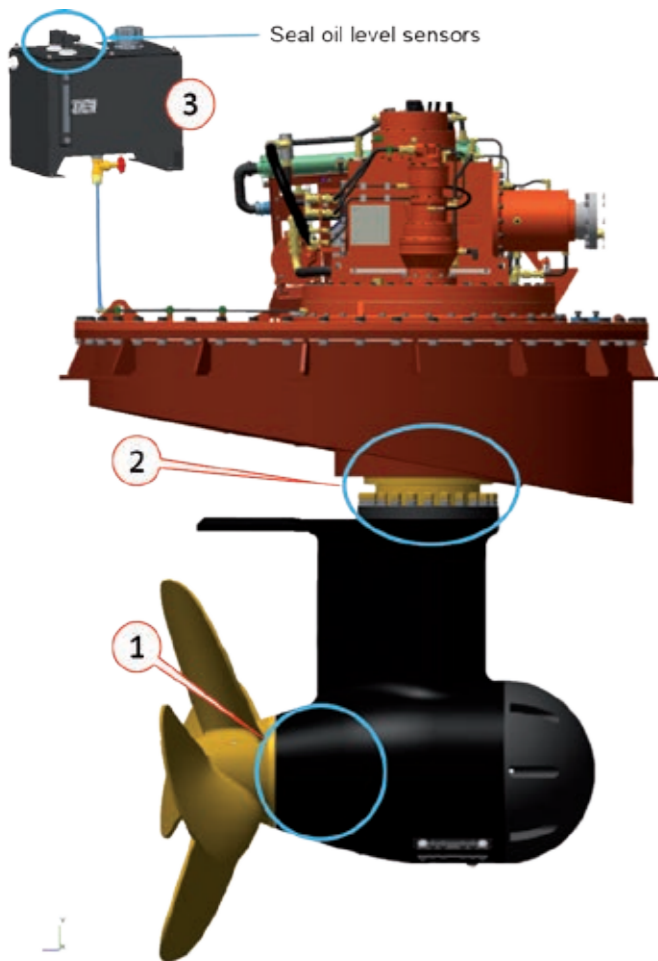

**Dynamic seal systems**

The seal system's primary function is to keep the thruster lubricant inside the thruster assembly, separated from the (sea)water. The two dynamic seals in the Veth Z-Drive Thrusters are the propeller shaft seals (1) and vertical steering tube seals (2).

Both seals have a so-called oil chamber which, depending on application, is statically pressurized with oil stored in a special seal oil tank. This makes it possible to monitor the seal condition. A V-ring below the vertical steering tube seals help to prevent the ingress of dirt and contamination.

**Header tank (Seal oil tank)**

The header tank (3) is used to store lubrication oil for the seal oil chambers.

**Level alarms**

Should a leak occur in either of the seal chambers, oil can leak away from, or water or lube oil can ingress into, the seal chambers. Loss of seal oil will cause the level in the seal tank to deplete which will activate a low seal oil alarm. Water or thruster lube oil ingress into the seal oil chamber will cause the oil level to increase which will activate a high seal oil level alarm.

Either alarm will provide ample time for troubleshooting and correction before a leak can cause damage to the gearbox, or oil leaking into the environment.

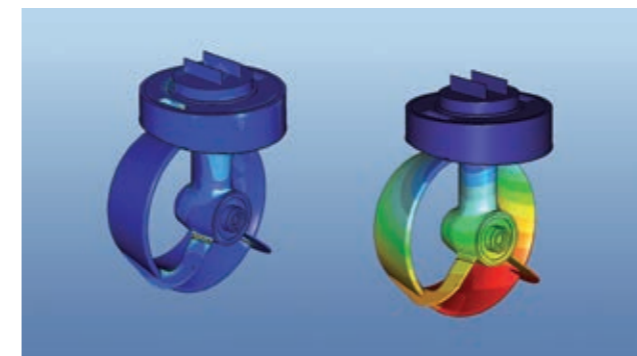

**Simulation Software for Robust Design Analysis**

Veth Propulsion uses Creo Simulate to analyse design concepts regarding the strength of thrusters to increase quality and innovation.

**Bureau Veritas CLEAN SHIP** 

Veth Propulsion is continually looking for solutions to meet the highest quality standards and latest regulations, including those for the environment. For example, by limiting of the impact of our operations on the environment. The Bureau Veritas CLEAN SHIP notation is an additional notation that imposes requirements on waste management, anti-fouling systems and sealing systems.

That is why we have over-developed a sealing system for all thrusters. These seals separate large quantities of lubricant from the environment - thus meeting environmental requirements while maintaining the performance of our high capacity thrusters.

# Drive options

The starting point for the choice of the appropriate rudder propeller is the sailing profile of your ship.

Based on that, you can opt for various drives:

- Diesel-direct
- Diesel-electric / LNG-electric
- Hydraulic
- A combination of the above

Diesel-direct driven Veth thrusters have a built-in clutch, with its controls integrated into the Veth Control System. A compact solution which makes the thruster easier to install.

### Horizontal vs. Vertical

In the case of electric and hydraulic units, you can also choose for a vertical drive: the Veth L-drive. Here, the motor is mounted vertically and the upper gearbox with optional clutch is eliminated. The integrated steering transmission, however, is the same as on a Z-drive.

An advantage of an L-drive is that, in the absence of an upper gear transmission, the resulting efficiency is higher than the one of a Z-drive.



Causeway | Diesel-direct

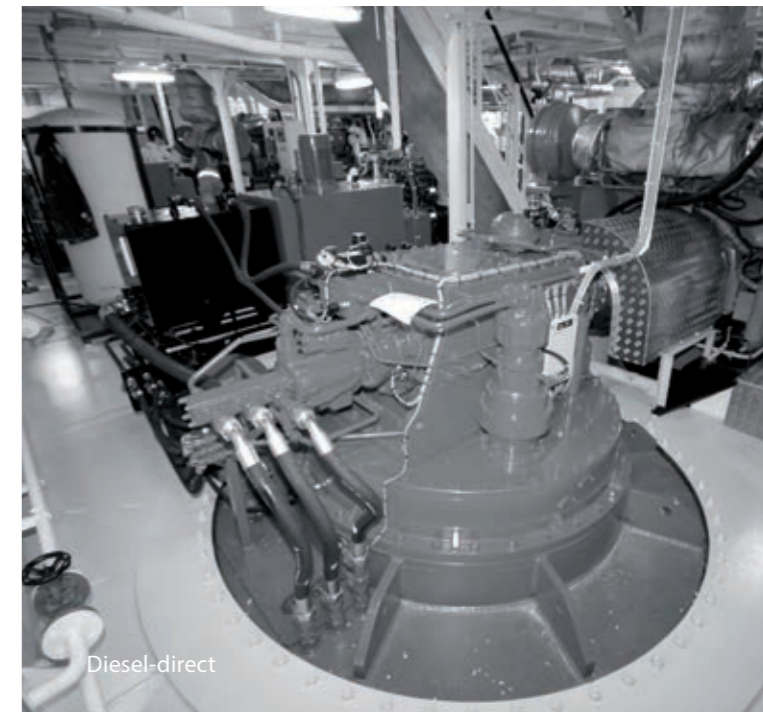

Diesel-direct



Cygnus | Diesel-electric

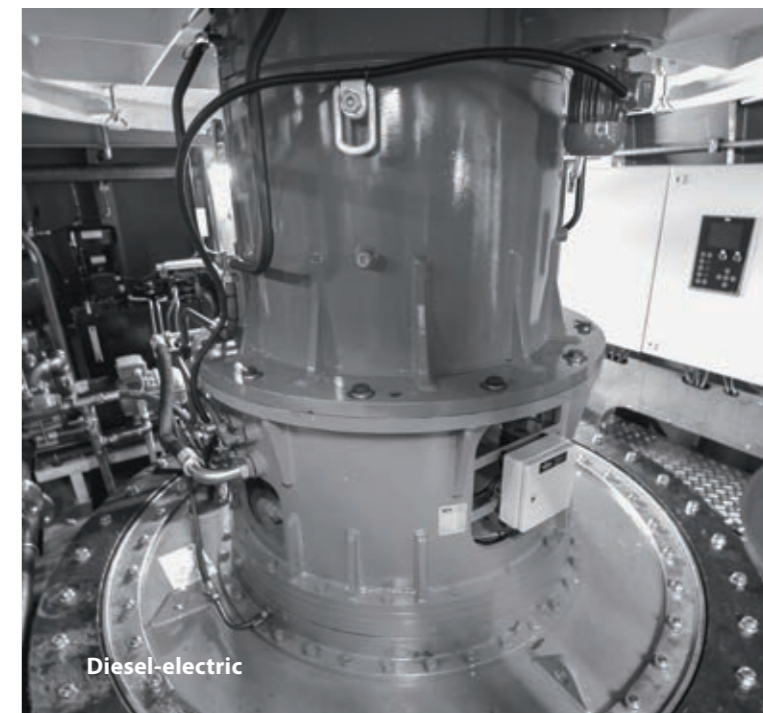

Diesel-electric



Alberto Aleman Zubieta | Hydraulic



Hydraulic



Greenstream | LNG-electric



LNG-electric

At both Veth Propulsion and Shipyard De Hoop, the customer comes first. Long-term thinking is more important than a quick win. An open relationship and a reliable product are the successful factors in our long-lasting collaboration.

Patrick Janssens, Managing Director Shipyard de Hoop

## Hybrid drive

Also for sustainable solutions, Veth Propulsion is the right address. Concerning the environment we are committed to making our contribution. One example is the Veth Hybrid Drive.

De Veth Hybrid Drive combines proven quality and technology with the latest hybrid insights. You can choose between two drives, diesel-direct or diesel-electric, or a combination of both. This enables you to use the particular drive within the portion of the power curve where the efficiency is most favorable. In short, providing you the solution to a wide range of sailing profiles! So you can always choose the most efficient way of sailing.

### Added value for you

- Better loading of the engine relative to the fuel consumption
- Higher redundancy compared to diesel- electric systems but with lower costs
- Lower fuel consumption over total speed range
- Lower maintenance costs
- Possibility to add batteries and sail in complete silence

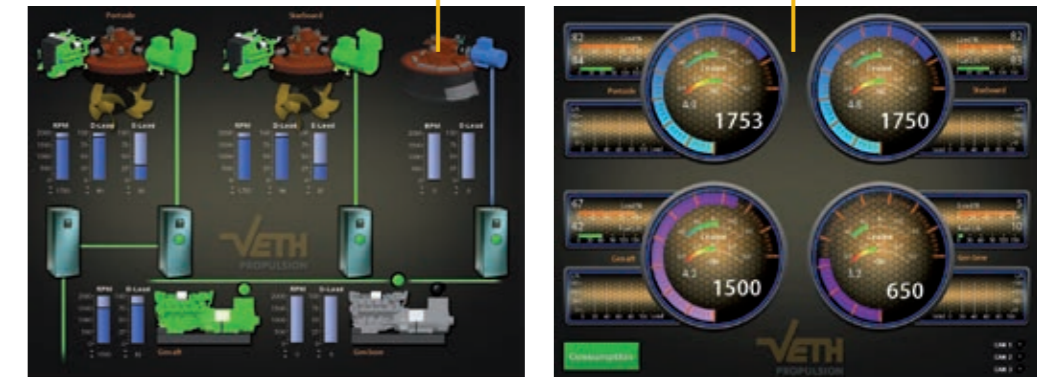

### Operation

In the low speed range, the thruster is diesel- / LNG-electrically powered by using the first generator. By an increase in the power demand the second generator is started. This generates better fuel consumption because the generator is optimally used according to the power requirements. The torque curve of an electric motor at low speed is more favorable in comparison to the torque curve of a diesel engine.

After further increase it is switched to diesel direct. The losses in efficiency by sailing with diesel / LNG-electric get so prevalent that diesel-direct drive will ultimately consume less fuel.

If you require maximum power out of the installation, in addition to the engines, you can also switch on the electric motors.

The Veth Hybrid Drive thus combines the advantages of both diesel-direct and diesel / LNG-electric propulsion.



Telstar | Type: VZ-1800-VHD



Eddy Tug







Semper Fi



Semper Fi | Type: VZ-900-CR-VHD

**Can be used as a generator**

An additional advantage of the Veth Hybrid Drive is that the electric motor can also be used as a generator. When the diesel engine is running at less than full power, there is enough power left over for the electric motor to be run as a propeller shaft driven generator, costing little extra fuel. The on-board generator sets can thus be switched off. This saves running hours, so maintenance costs.

**Battery pack drive**

The system is also suitable to drive the electric motor via a battery pack.

The battery pack can be connected directly to the DC bus of the inverter so you can sail without running the engines.

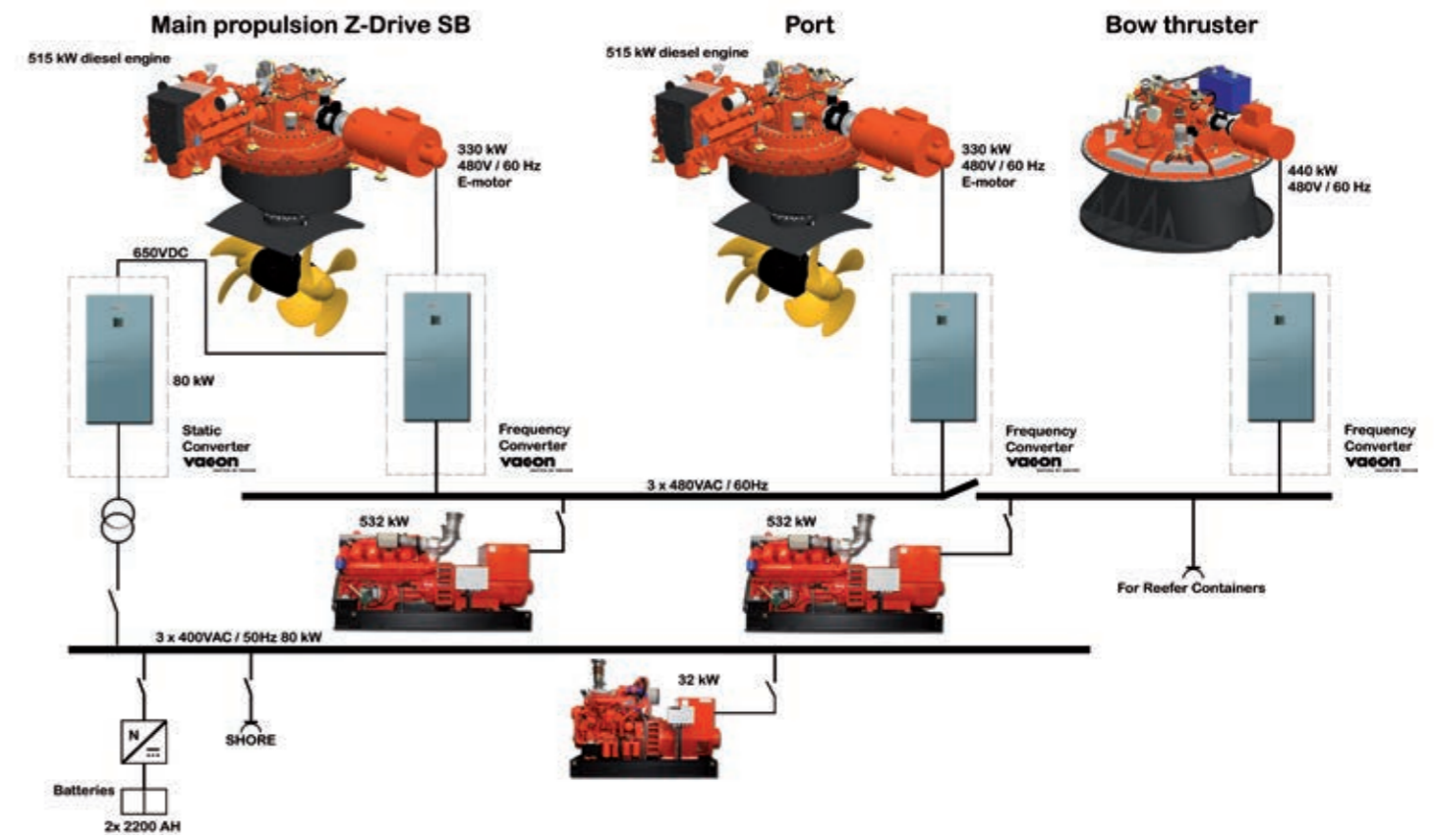
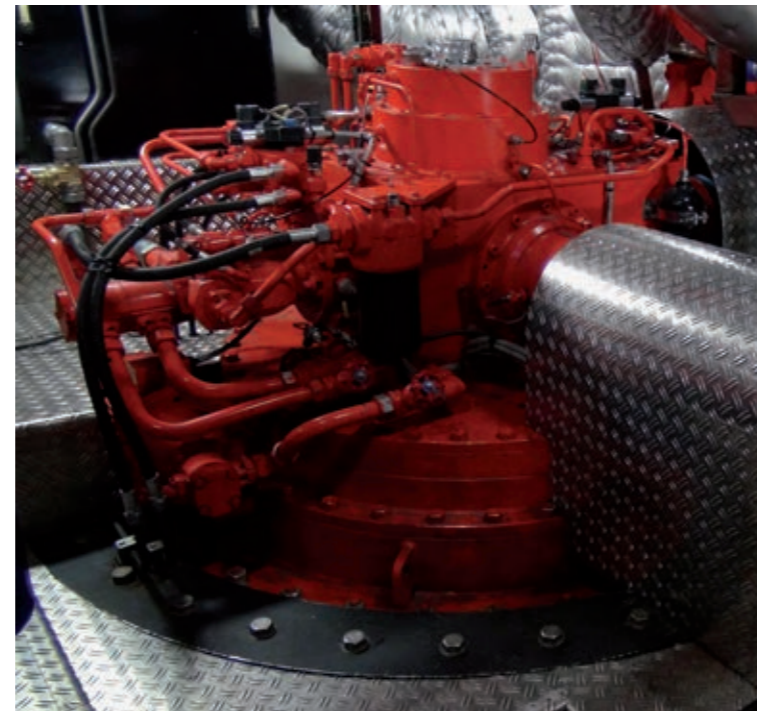
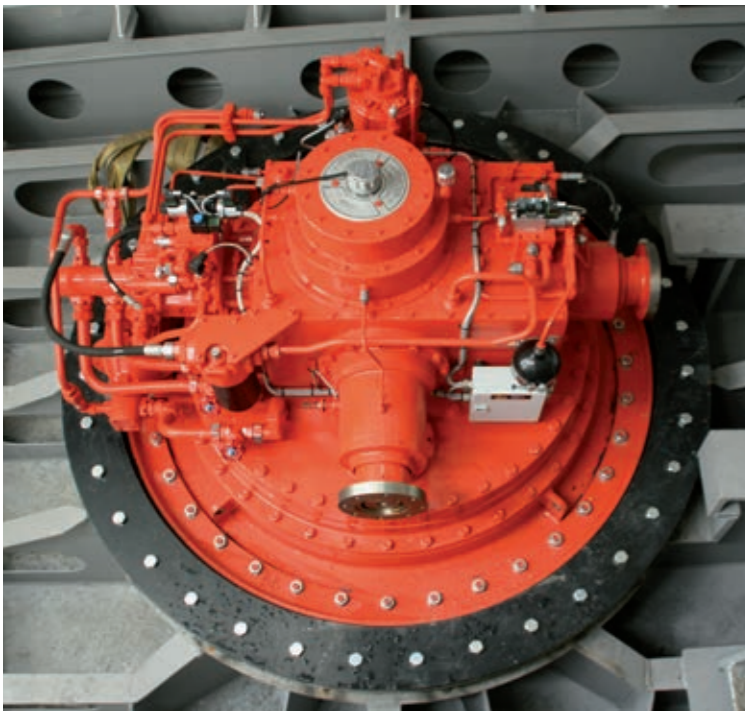

# Executions

The type of rudder propeller that best suits your needs, depends on factors such as the type of vessel, available space and the desired maneuverability. Read more about the Veth retractable thruster, the Veth Swing Out, the deck-mounted thruster and the portable propulsion solution.

If you need a 360 degrees steerable thruster to be used as auxiliary propulsion, then a retractable thruster might be interesting.

A big advantage of our retractable range is the use of components from the Veth standard azimuth thruster range. A retractable thruster provides hydraulic lifting and lowering of the unit, enabling it to retract into the hull when not in use. It reduces the vessel's resistance e.g. during transit to or from the operation area; retraction of the thruster also enables sailing in shallow waters. By rotating the underwater part through 360°, the full propulsive power can also be used for manoeuvring and for dynamic positioning (DP) of the vessel. The Veth retractable thrusters are available in a vertical retraction system to minimise space requirement in the vessel. Both Z- and L-drive options are available to match vessel types according to different inboard height availability. A Veth retractable thruster is already starting at 50 kW (VL-50). Ask our Sales Team for the possibilities and applications.



Acta Orion | Type: VL-900-Retractable

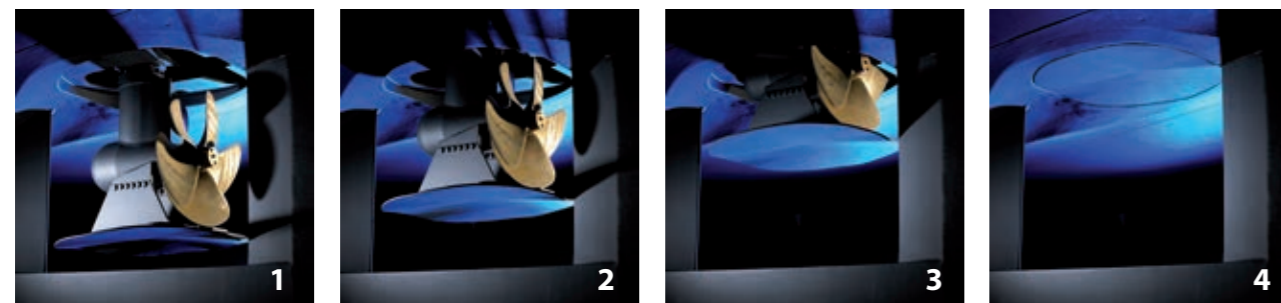

Deep Helder | Type: VL-400-Retractable

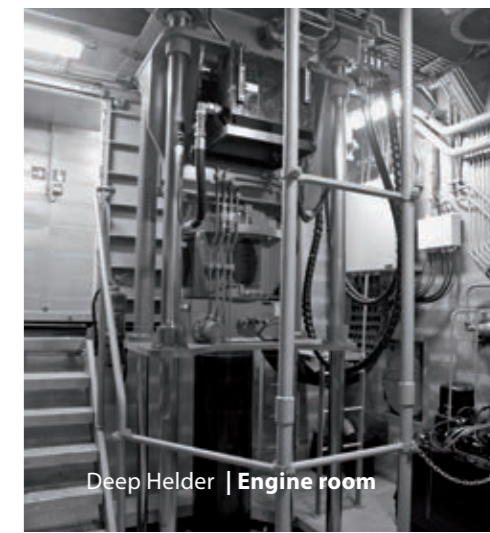

Deep Helder | Engine room



Acta Orion | Type: VL-900-Retractable



Acta Orion | Engine room

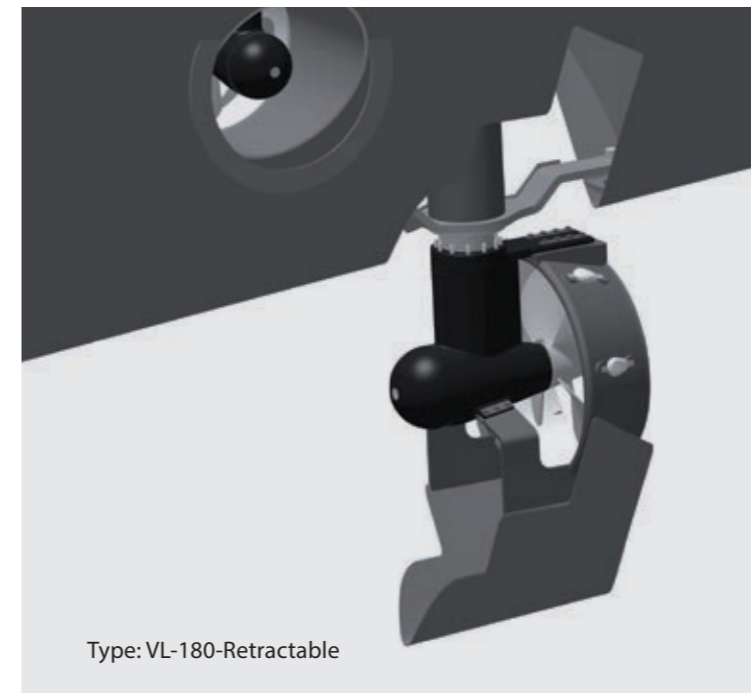

Type: VL-180-Retractable

Type: VL-180-Retractable



Seacor Puma | Type: VL-180-Retractable

## Veth Swing Out

If you need a retractable 360 degrees steerable thruster which is to be used as auxiliary propulsion and there is limited height available, then a Swing Out may be of interest to you. These can be folded fully flat inside the ship, ensuring a low construction profile.

The Veth Swing Out uses components from the Veth standard azimuth thruster range and can be hydraulically lowered out of the vessel's hull and can be steered limitlessly through 360 degrees once it has reached the fully folded out position.

The Veth Swing Out is particularly advantageous for mega yachts. The retractability of the Veth Swing Out has enormous benefits for large vessels in particular. This auxiliary propulsion system significantly increases vessel manoeuvrability and the vessel can be steered more precisely when entering and leaving port. Retracting the auxiliary propulsion units once they are no longer needed, and when cruising in the open sea, is beneficial with regard to speed, fuel consumption and CO2 emissions.

### Cooperative designing

When designing the Veth Swing Out, we look at the available space and its possibilities. The Veth Swing Out is integrated into the vessel's structure and you can count on the proactivity of Veth Propulsion to find together the best solution to integrate it into the lines plan of your vessel. The Veth Swing Out becomes part of the ship's structure and thus takes up as little space as possible. The basic structure is built in-house and customized according to your wishes.



Oceanco | Type: VZ-400-Swing Out



Sanmar Shipyards is very satisfied and impressed about the performance of Veth Z-drives and the service of the company. Therefore we had no hesitation in selecting them for the tug boats we need for our own operation.

Ali Gürün, Managing Director Sanmar Shipyards



GMK-1



GMK-1 | Type: VZ-550-Deck



GMK-1 | Type: Scania DI-13



Rota Kemal | Type: VZ-400-Deck



Type: VZ-400-Deck



Lifting / tilting

## Deck mounted Veth Z-drive

If your vessel is not equipped with an engine room, then a deck set may provide an interesting solution. The installation can be driven electrically, hydraulically or by diesel engine.

### Four versions

The deck set is available in four different versions:

- Permanent emplacement
- Lifting: rudder propeller is raised/lowered vertically
- Tilting: rudder propeller can be tilted at an angle
- Combination of lifting and tilting

### Lifting

For maximum efficiency the propeller should be below the baseline of the vessel but when the vessel sails in shallow water there are limitations for positioning the propeller. A thruster which is adjustable in height may be the answer. This lifting system is constructed from two sliding rods near the upper gearbox and a clamp around the vertical outer tube of the thruster. Hydraulic cylinders move the complete thruster up and down.

### Tilting

Removing debris from a propeller is made easier when the thruster can be tilted. Hydraulic cylinders and a strengthened upper gearbox make an easy-to-operate tilting system. It also makes it possible to exchange the propeller without dry-docking the vessel.

A tilting system is worth the extra effort when a vessel sails in waters with a lot of floating debris.

The major advantage of a deck set is that the Z-drive is easy to install and to replace. The deck set is also easily accessible for servicing.

### Lifting system

If your empty vessel has a tendency to draw in air at the propellers, a thruster lifting system can provide an appropriate solution. This allows the propeller to be adjusted in height. An empty vessel no longer requires ballast, but can lower its propeller to the required height.



JUB | Type: VL-900

## Portable propulsion solution for (jack-up) barges

This is a transportable and complete propulsion concept invented by Veth Propulsion in collaboration with various suppliers and specialists. Veth Propulsion has combined all the expertise and developed this innovative concept consisting of Veth L-drives (A), power pack containers (B) and a control container (C).

The innovative aspect of this concept is that existing (proven) techniques are used together in combination. The premise was again simplicity. By utilizing hooks on the sides of the platform, the thrusters can easily be (dis)assembled. This allows a single system to be used on multiple platforms, a huge cost savings for you as a user.

The configuration of the power packs and thrusters are available in various design combinations.

### The advantages

- Cost savings compared to conventional systems
  - Platforms are hereby self-propelled and independent, requiring no support tugs, and without the costs of vessels with permanent propulsion
  - Transportable, making them deployable on a variety of different platforms with relatively minor changes
  - Small investment necessary for renting the platform with thrusters (thruster system is separate)
- Enormous time savings
  - By using the thrusters instead of the anchors (standard solution) to bring the platform into position, a great amount of time can be saved.



## Jack-Up Barge

Veth Propulsion delivered four retractable L-drives in easy-to-install housings. These portable L-drives are equipped with four containers housing diesel-electric power packs, and are automatically controlled via the control container that is equipped with a redundant dynamic positioning system.

The system has been extensively tested and Jack-Up Barge has been serving its customers satisfactorily with this unique system.



Veth L-drives



Power pack containers

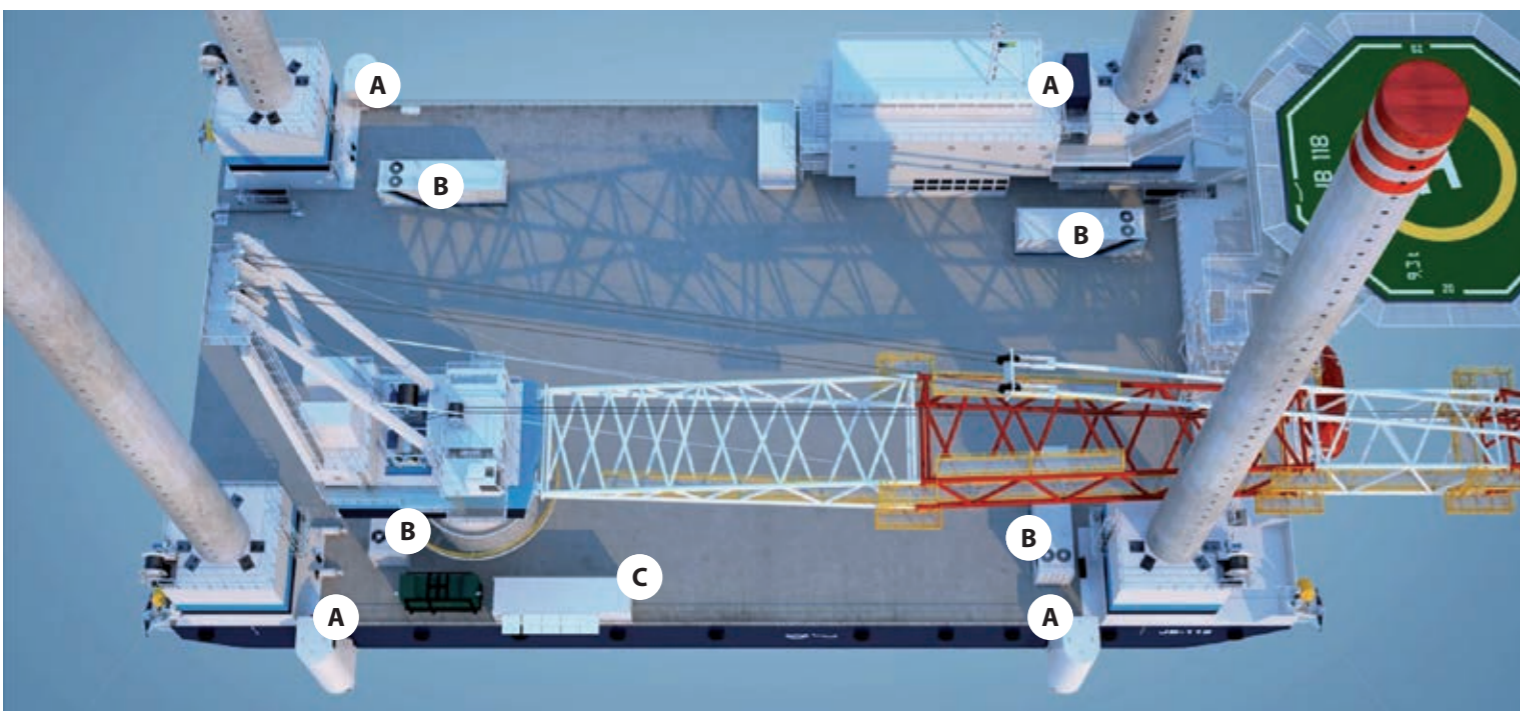

Veth L-drives

Control container

Operation



Type: VZ-1800 with VG40 nozzle



# Type of propeller

All Veth thrusters are available with either an open propeller, counter rotating propellers or with a nozzle. The choice of propeller depends on speed, draft and your sailing profile. For every situation we offer a suitable solution!

### Each project is customized

Each propeller is designed for a particular project. The skew of the propeller is used to lower the sound level. A 4 or 5 blade propeller is chosen, depending on factors such as torsional vibration calculations and noise requirements. Veth Propulsion uses propellers made of CuNiAl, an alloy of copper, nickel and aluminum. CuNiAl propellers offer excellent resistance to erosion and cavitation.

### Hydraulic mounting

Our propellers are standard hydraulically mounted allowing simple disassembly (without a torch). For this reason, the hub of the propeller does not deteriorate in contrast to assembly with key and keyway.

Veth Propulsion operates on a proven concept where a labyrinth is incorporated in the propeller hub. A great advantage is that the seal is well protected from fishing line or ropes.

## Open propeller

For higher speeds, an open propeller is a better choice than a propeller with a nozzle.

## Nozzle

### High thrust at low speed

If high thrust at low speeds is important for you, then a nozzle is the best solution. The lifting action of the nozzle profile tends to pull the nozzle forward. How does this work?

On rudder propellers with a nozzle, the velocity of the water flow is increased and the pressure is reduced. As a result, the thrust and the torque of the propeller decreases slightly, while a circulation with inward-directed force takes place. This force provides for a forward-acting element, giving the nozzle a positive thrust which is generally larger than the reduced thrust of the propeller. Due to the small clearance between the nozzle and the tip of the propeller blade, the tip vortices are reduced thereby increasing efficiency. However, the frictional resistance of the nozzle increases as the speed increases, and will eventually become greater than the additional thrust. The nozzle is thus ideal for providing greater pulling power for heavy loads, but less suited for high speed vessels.

The advantages summed up of a nozzle compared to an open propeller:

- 20 to 25% more thrust at low speeds
- The nozzle provides the propeller some protection
- Higher "bollard pull"

Air intake at shallow draft can be avoided by placing an anti-vortex plate above the propeller.

### Two types of nozzle

Veth Propulsion uses two types of nozzles: VG40 and VOB50 (optimized nozzle 19A). On both types the nozzle is suspended on three points, and the lining is made completely of stainless steel. The top of the nozzle is flanged and bolted, making it relatively easy to disassemble. Depending on your application, you can choose for the best option.

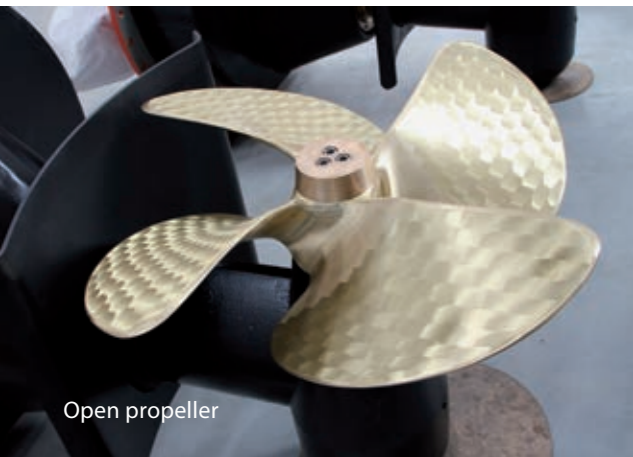

Open propeller

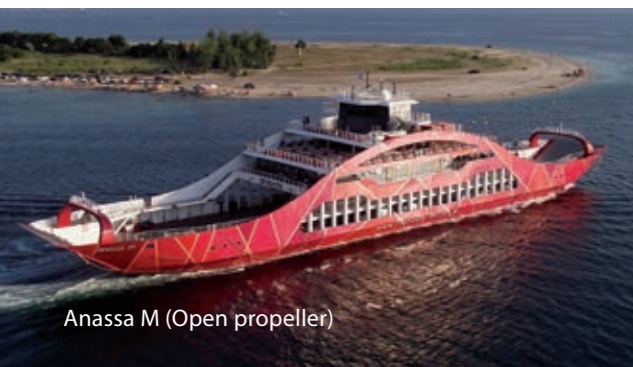



Anassa M (Open propeller)



Contender (VG40 nozzle)



Yenicay (VOB50 nozzle)

VG40	VOB50
	
The length is 40% of the propeller diameter	The length is 50% of the propeller diameter
Combination of high thrust and low resistance	The inlet of the nozzle (modelled after the 19A) is slightly enlarged in order to improve the flow to the propeller. Due to the enlarged entry this nozzle offers more resistance, so if the vessel speed is important then a VG40 nozzle is recommended. This type of nozzle is often used with tugs. Bollard pull efficiency is 2-3% higher than a VG40 nozzle.
Suitable for higher speeds	Delivers more thrust at low speed

## Counter-rotating (CR) propellers

Does your vessel have a shallow draft and you find low noise levels important? Then counter-rotating propellers may be of interest to you. Because the power is divided between two (smaller) propellers which rotate in opposite directions, a higher efficiency can be obtained with respect to a single propeller.

### Operation

The CR unit consists of two propellers rotating in opposite directions relative to each other, wherein the second propeller removes the whirling of the water caused by the first propeller. This results in minimal rotational losses with optimal efficiency from the available power and propeller diameters.



Anesha (CR propellers)



Genesi (CR propellers)



Pão de Açúcar (CR propellers)



Genesi

### Low noise

The counter-rotating propellers give a new dimension to efficient and low-noise propulsion. Because the optimum engine speed is more than 20% lower in contra-rotating propellers than in a single-propeller or in which two propellers rotate in the same direction, there is also an extremely low noise level. Also, the low blade load and the reduced turbulence in the water contribute to lower vibration and noise production.

### Benefits

In contrast to other suppliers, Veth Propulsion offers a CR solution in which the propeller is mounted on two sides of the tail unit. This has a number of advantages:

- The peripheral speed of the shaft seals is half that of systems with two propellers on one side, in that a shaft does not rotate inside another shaft.
- Two separate (solid) shafts are each loaded between 45 - 55% of the output power

- A durable bearing and seal is thus created, compared with two propellers on one side
- By making use of a four-blade and a five-blade propeller, the power is distributed over nine blades
- Less time in dock during dismantling. Seals remain in position when the propeller is removed and oil change is not necessary
- At an equal propeller diameter, an efficiency gain of 15 to 20% is achieved compared to a single propeller

Veth Propulsion operates on a proven concept where a labyrinth is incorporated in the propeller hub. A great advantage is that the seal is well protected from fishing line or ropes.

In short, a counter-rotating Z-drive of Veth Propulsion makes the combination of high efficiency, small propeller diameters and low noise possible.

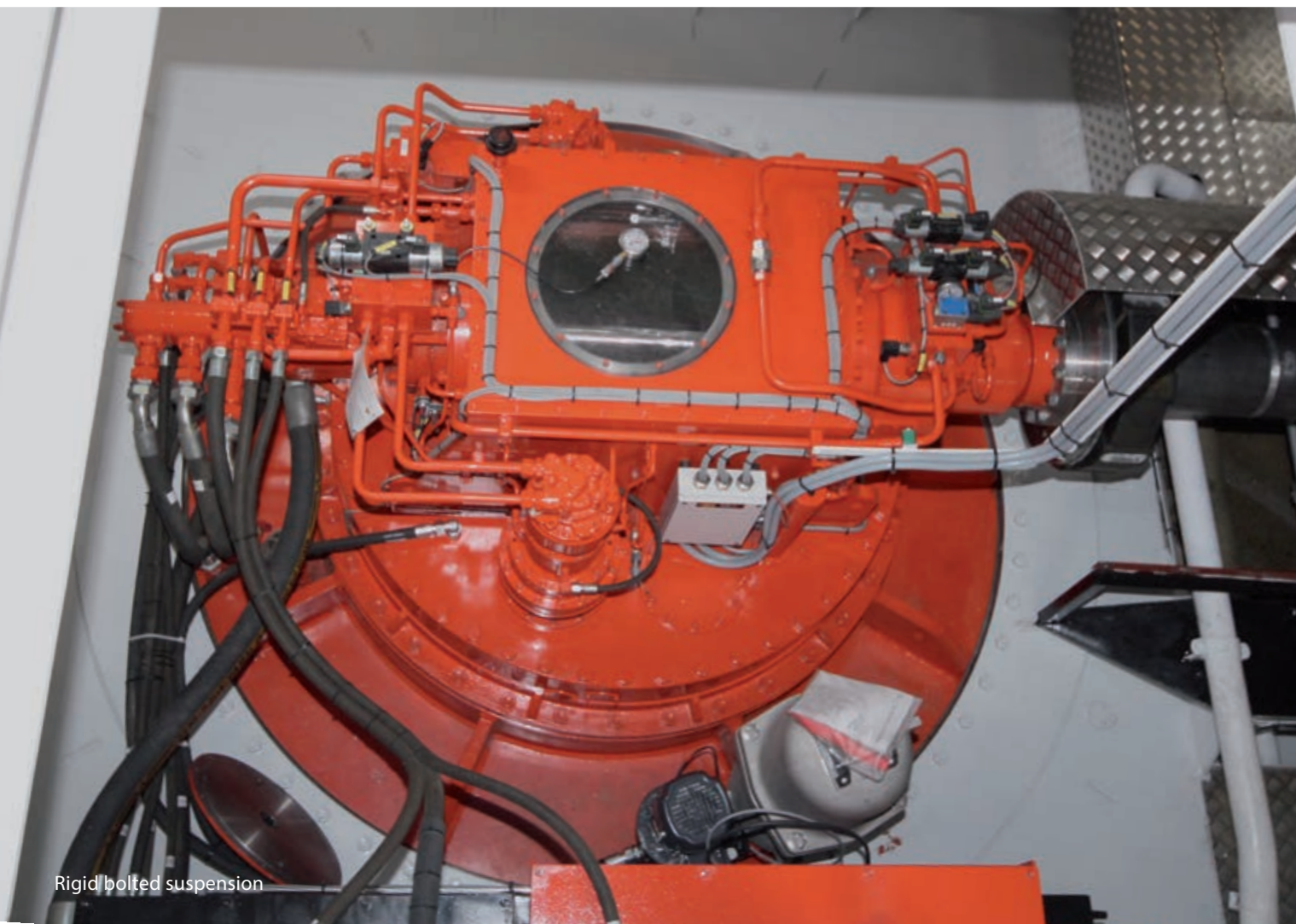

Rigid bolted suspension



Rigid welded suspension

## Thruster foundation and suspension

The main foundation of a Veth thruster can be made into any particular shape to fit the vessel as effectively as possible. Veth Propulsion uses three different types of suspension for installing her thrusters. Rigid welded suspension, rigid bolted suspension and flexible suspension.

In addition, the overall width/diameter of a bottom well for top-mounted thrusters must allow for the propellers and tail section to fit during assembly. A bottom well for bottom-mounted thrusters needs only to accommodate the thruster's gearbox and top plate assembly, thus requiring a smaller diameter.

The major difference between a top and a bottom-mounted flexible suspension is that although the same components are used, the method of mounting determines the order of assembly.



Top mounted

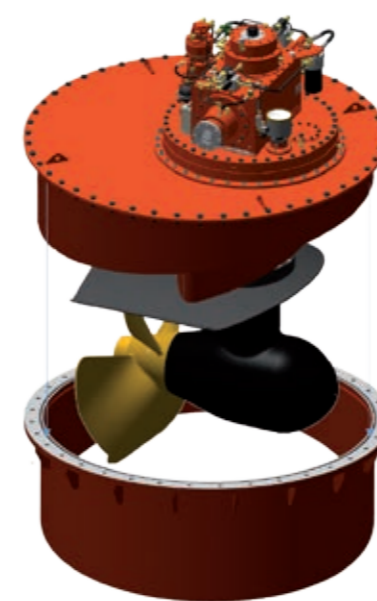

Rigid bolted suspension

Bottom mounted

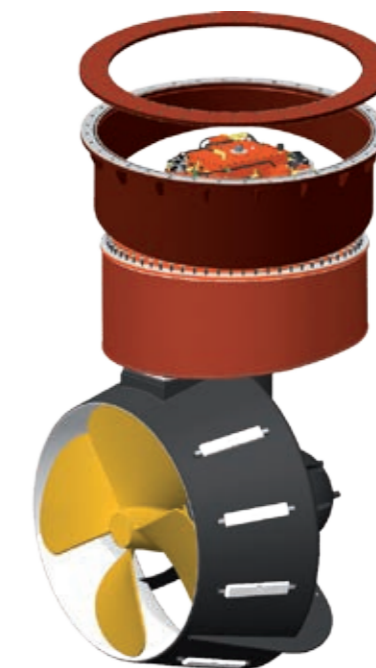

Rigid bolted suspension

Top and bottom mounted



Flexible suspension



## Bottom mounted



### Rigid welded suspension

The thruster can be welded into the hull of the vessel; all foundation elements will be welded as an integrated part of the vessel.

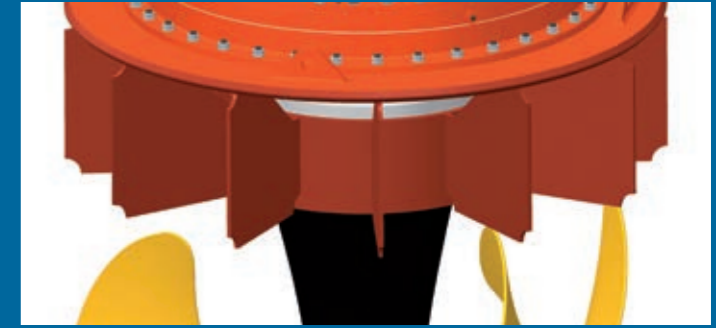

### Rigid bolted suspension

The thrusters can be built into the vessel on a rigid suspension foundation, where the thruster is bolted directly onto the bottom well.

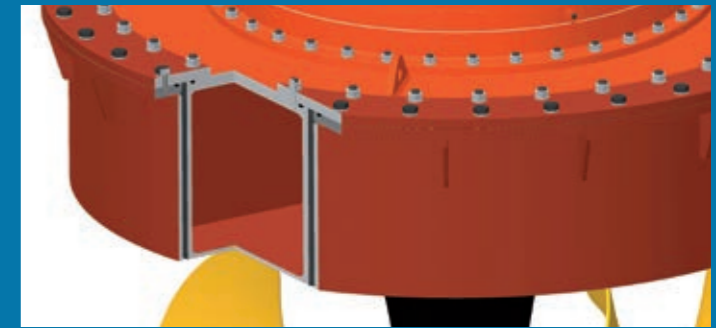

### Flexible suspension

The thrusters can be mounted in a flexible suspension bottom well, to suppress noise and vibration when operating. To create a flexible suspension, rubber isolation rings are inserted between the upper foundation and the bottom well.

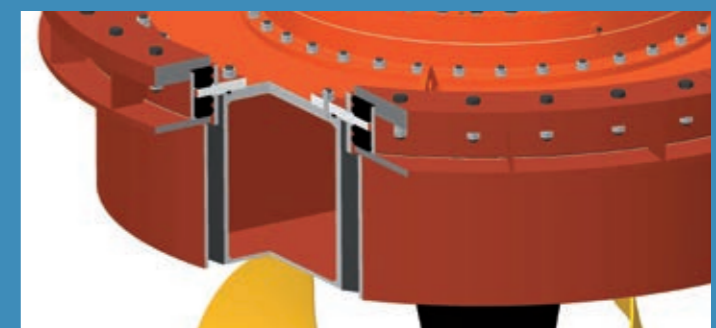

# Veth Integrated L-drive: the most compact propulsion system

Now, Veth Propulsion is presenting a revolutionary concept in the field of electric propulsion: the Veth Integrated L-drive. This innovation offers the following benefits:

- Compact design: extremely low mounting space requirements
- High efficiency
- Quiet; minimal noise production
- Built using proven Veth Propulsion technology
- Outstanding manoeuvrability thanks to the 360-degree thrust
- Low weight
- Electric motor inside the ship; few vulnerable components underwater
- Simple to install
- Slip ring cabinet unnecessary
- Optimal flow of water thanks to 'Shark Tail' on counter-rotating propeller

## Electric propulsion

Veth Propulsion designs and manufactures different types of azimuth thrusters. Azimuth thrusters are capable of 360-degree propulsion. Which azimuth thruster suits you best depends on the type of ship, the type of drive and associated requirements. A diesel-electric driven propulsion is a commonly chosen solution. We also see a trend developing in the use of alternative fuels, such as LNG and, in future, hydrogen (for fuel cells) in order to reduce CO<sub>2</sub> emissions. These motors often run at a constant RPM: in this case, electric drive is an ideal solution. The constant speeds can be converted to variable speeds by means of a frequency drive. An additional benefit of electric propulsion is redundancy.

For electric propulsion, you can choose between a Veth Z-drive and a Veth L-drive. A Z-drive has two gears, whereas an L-drive has one. Each gear transmission results in a 1% efficiency loss.

In addition to higher efficiency, an L-drive is also less expensive to install. That is why an L-drive is preferable, provided there is enough space for the electric motor.

Until now, asynchronous short-circuit anchor motors have been widely used. Veth Propulsion has developed the Veth Integrated L-drive with a permanent magnet (PM) motor.

The PM motor was designed in collaboration with Visedo and allows for a much lower mounting height. While designing this innovation, a conscious choice was made to house this PM motor inside the ship. The major advantage of this choice is that the PM motor is much less vulnerable than if it were located underwater.

The Veth Integrated L-drive is available with power ranging from 300 kW to 2,350 kW. Larger units are still being developed and will eventually also be available. The Integrated L-drive can be fitted to various types of vessels, ranging from huge luxury yachts to work boats.

The Veth Integrated L-drive is constructed using technology that we are familiar with. For example, Veth Propulsion has already made 1,500 of the underwater housings that are used for this new concept.

Space - efficiency - noise reduction are essential principles we adhered to during the development of the Veth Integrated L-drive.

### Space

The patented and innovative Veth Integrated L-drive is constructed using proven mechanical components. The PM motor is integrated into the thruster. When designing this thruster, no concessions were made with regards to the hydrodynamic design of the submerged section. The thruster is optimally streamlined thanks to the small diameter of the underwater gearbox.

## 40 - 60% more compact

The design makes use of every millimetre, without compromising quality. On average, a PM motor is 40% to 60% more compact than an asynchronous motor. This PM motor, when combined with the special mounting method, the alignment of the headsets and the adjustments to the control box, makes for a very compact thruster.

This minimal mounting height allows the thruster to be fitted below deck height, so that few vulnerable capital assets are underwater. In addition, this means that the thruster is easily accessible for periodic servicing.

In addition to the compact design, on average a PM motor is 30% - 60% lighter than an asynchronous motor.

The figure below shows a comparison of the heights of the VL-550 (550kW) and the VL-550i (550kW).

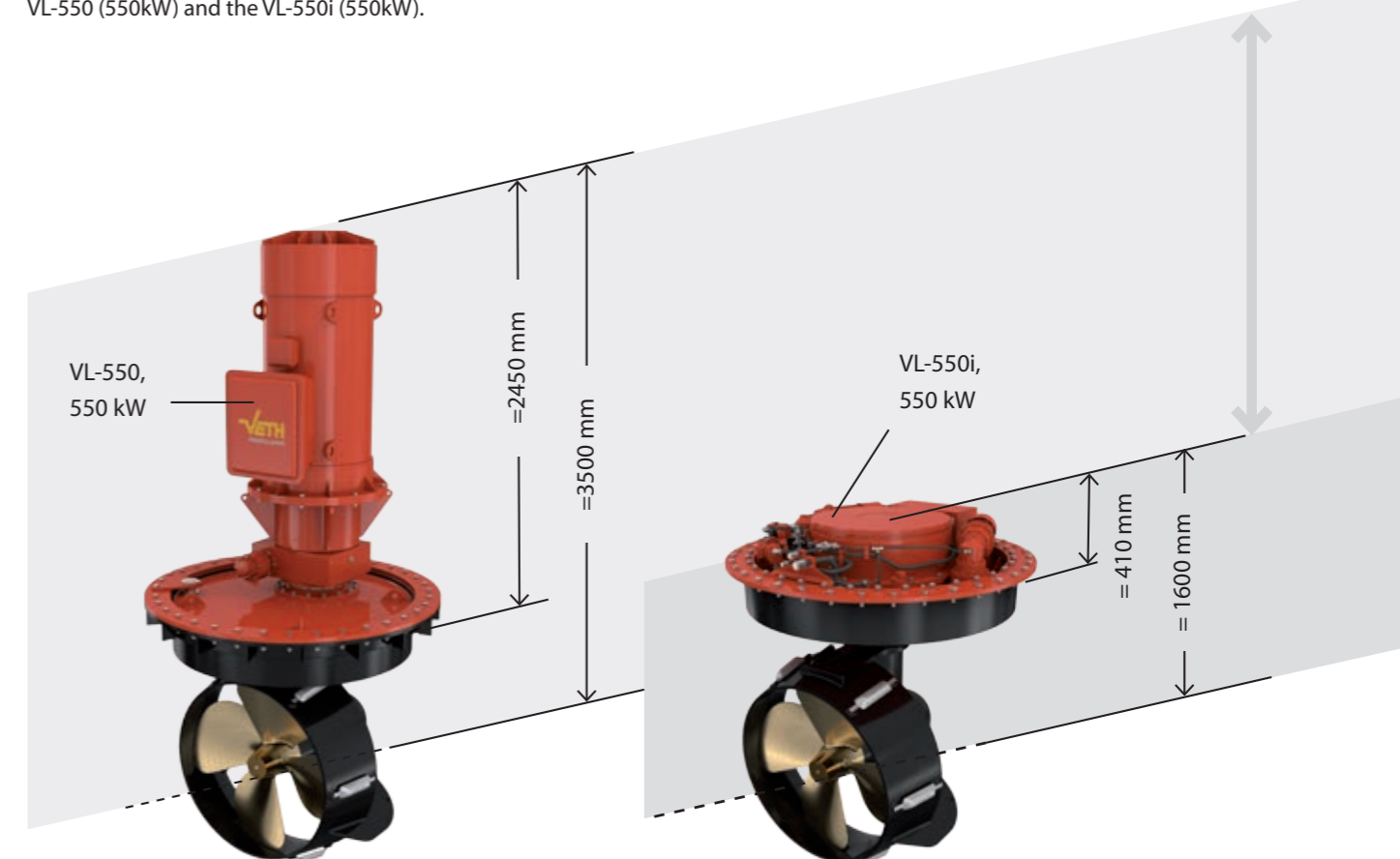

## Efficiency

### Efficiency improvement till 5,2%

A PM motor is more efficient than an asynchronous motor. In particular, the part load efficiency is higher. In the diagram below, a PM motor with an output of 375 kW is compared with an asynchronous motor of the same output.

At 100% load, the efficiency of an asynchronous motor is 95,7%, and that of the PM motor is 97,2%: an improvement in efficiency of 1,5%. At 25% load, the efficiency of an asynchronous motor is 91,6%, and that of the PM motor is 96,4%. This means an improvement in efficiency of 5,2%.

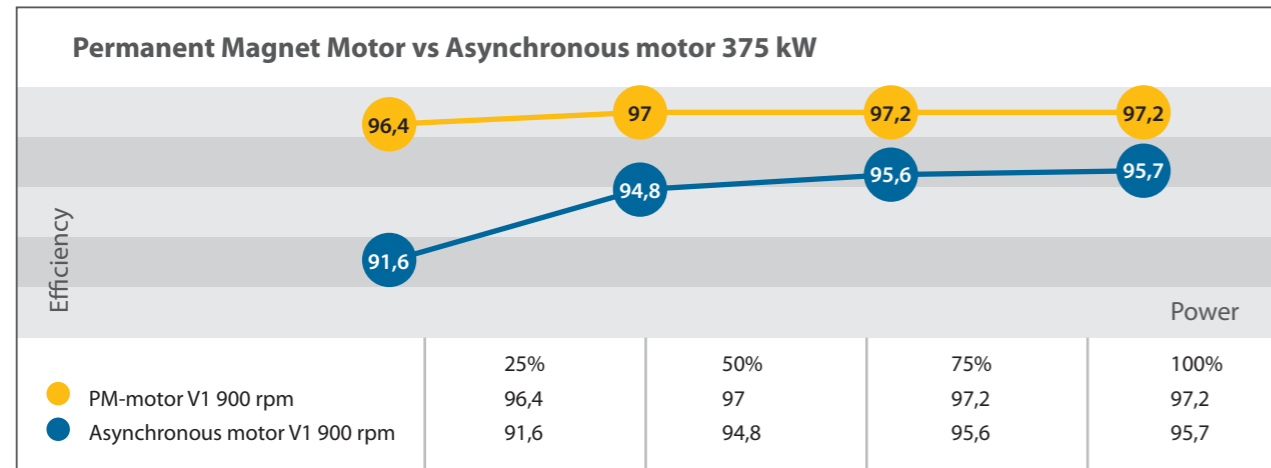

## Noise Reduction

The Veth Integrated L-drive does not have a gear transmission in the ship, which means that it generates less noise. The PM motor is water-cooled, which produces less noise than the air-cooling of an asynchronous motor. In addition, the Veth Integrated L-drive is electrically controlled, which further reduces noise production.

The Veth Integrated L-drive is simple to install. It can also be mounted flexibly. The mounting box is fitted with a clamping edge, which is hung between two rubber rings.

### Benefits:

- Very quiet when in use due to flexible suspension
- Easy to remove thanks to mounting via the underside of the ship

All of these benefits ensure that this thruster is a very quiet propulsion device, which make it ideally suited for luxury yachts, for example.

## Fairing plates

The Integrated L-drive is fitted with streamlined fairing plates, which reduce resistance. The fairing plates are flow caps which are affixed around the stationary parts of the thruster. They are shaped according to the surface of the ship, and help to reduce drag.

Depending on the application, the thruster can be fitted with an open propeller, a nozzle or counter-rotating propellers.

## Patented Shark Tail

For fast ships with shallow drafts or when low noise production is paramount, a counter-rotating propeller is an attractive choice. A patented Shark Tail is used for this tail. The tail has been further optimised using CFD calculations and as a result it is shaped asymmetrically (see image no 1). This shape ensures an optimal flow of water toward the second propeller. This innovation was developed in collaboration with Promarin and leads to a reduction in drag and noise production.

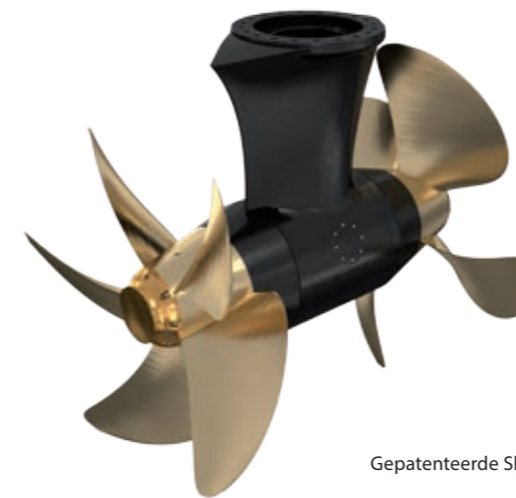

Gepatenteerde Shark Tail

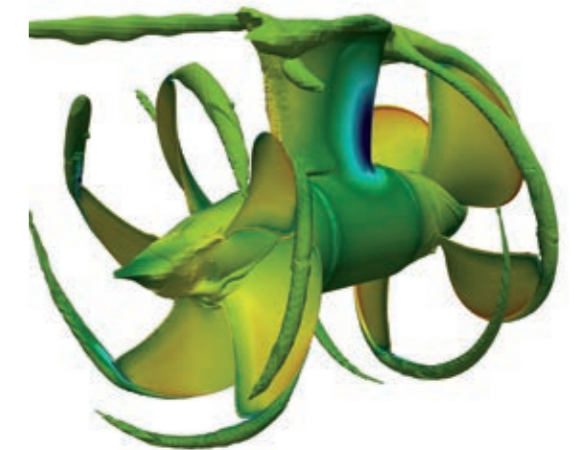

CFD resultaat van Shark Tail

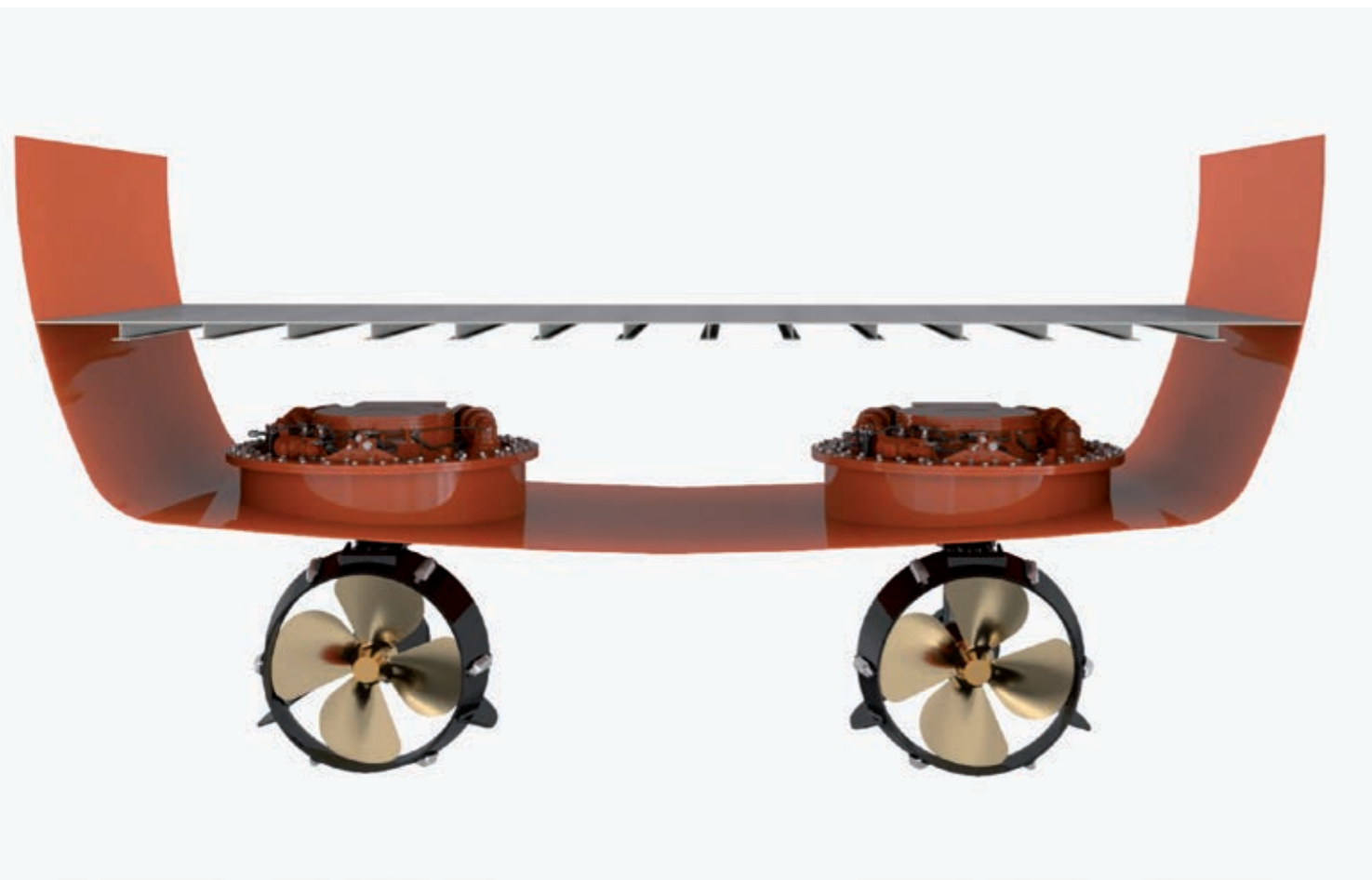

Type: VL-550i Courtesy of Damen Shipyards



Type: VL-700i Design by Vripack

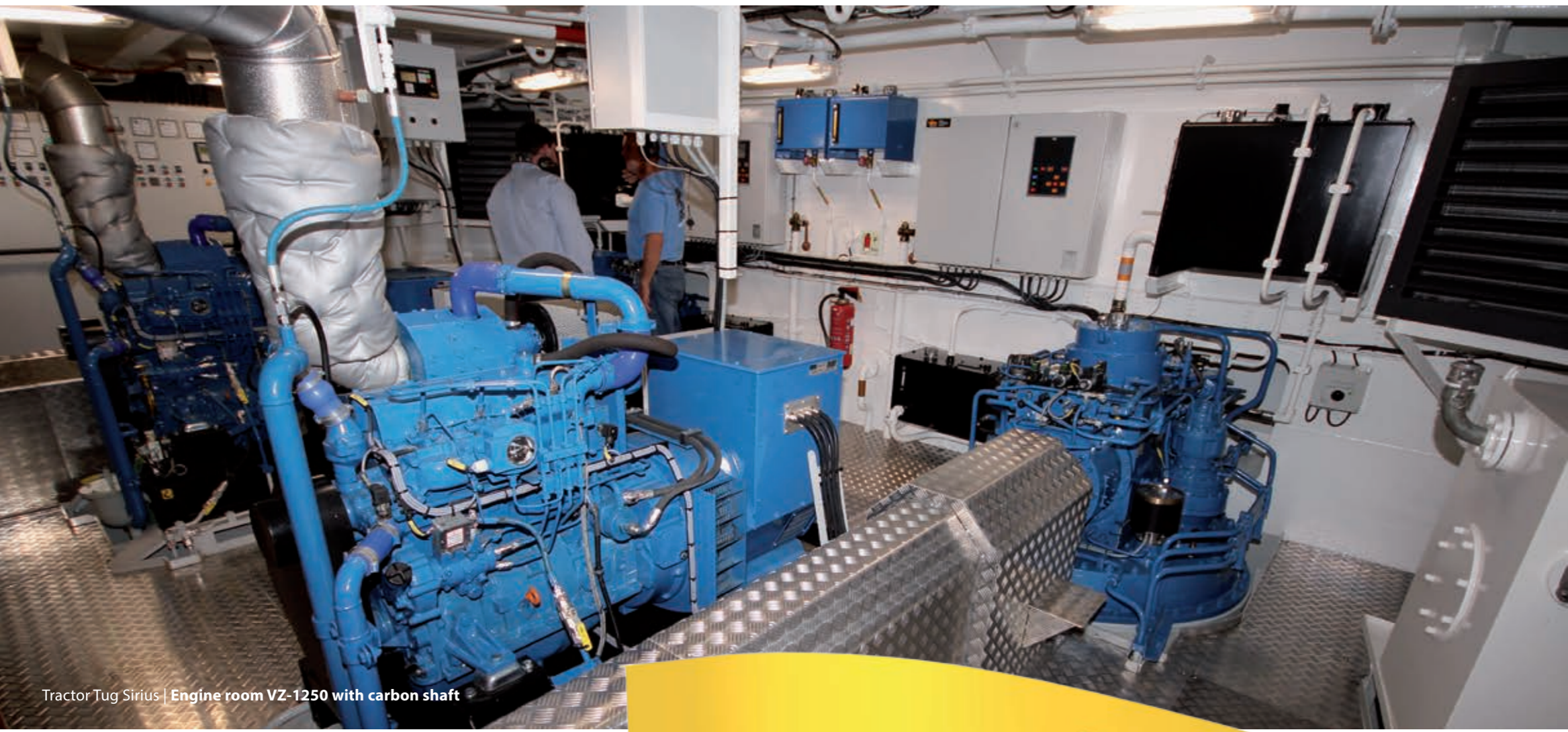

Tractor Tug Sirius | Engine room VZ-1250 with carbon shaft

## What makes Veth Propulsion your number one supplier for refits?

- No fixed center-to-center distances. Your thruster will be completely tailor-made for your vessel
- Extensive range of mounting principles. Our thruster will fit your vessel as if it was part of the original build
- Veth Propulsion works together with all engine manufacturers. Also older engine arrangements can be interfaced with current technologies
- Veth Propulsion is able to offer a complete driving line including shaft line
- Our engineering and R&D departments are especially equipped for this type of projects. The demanding environment of an existing vessel and the design limits which come with it, are all taken into account to achieve a project specific design

## Refit

Underlining our core values and working standards, Veth Propulsion is also a good choice as your supplier for refit projects. Veth Propulsion is able to take measurements on board, as well as incorporating old (blue-print) drawings in 3-D modelling software. This makes our robust propulsion solutions fit each and every vessel and application as a tailored installation.

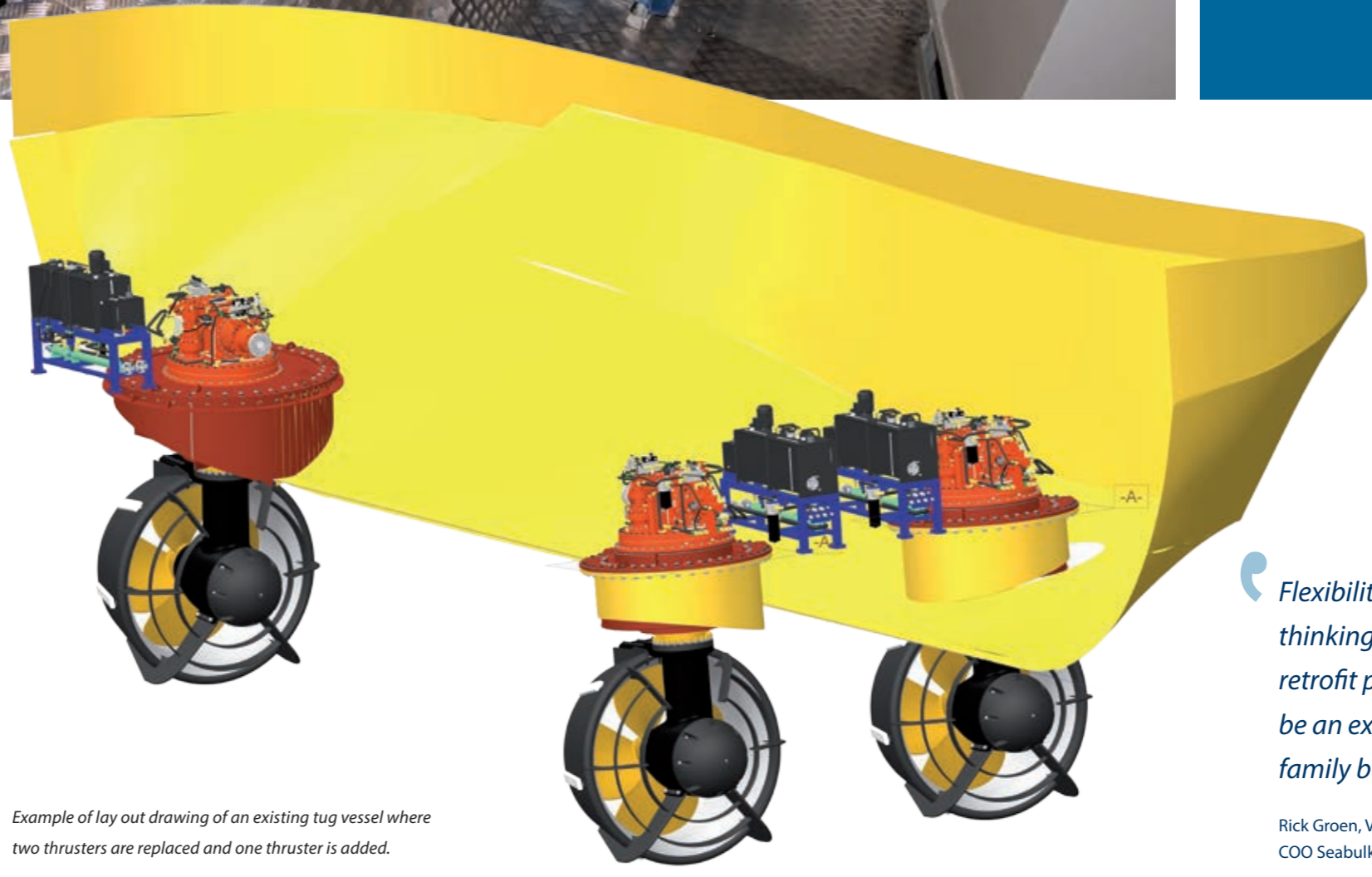

Example of lay out drawing of an existing tug vessel where two thrusters are replaced and one thruster is added.

*Flexibility, fast switching and pro-active thinking were of great importance for our retrofit project. Veth Propulsion proved to be an excellent partner for us; a compact family business, yet world class player!*

Rick Groen, Vice President Operations Seacor Ocean Transport, COO Seabulk Towing

# Veth Control systems

Like all of our products, our control systems are also developed and produced in-house. The Veth Control Systems (VCS) offer you the opportunity to read out, monitor and analyze data and alarms.

## Own R & D department

Veth Propulsion has its own R&D department for electronics, which is engaged with in-house development, innovation and improvement of our control systems on a daily basis. This is in line with the everything-under-one-roof principle and offers several advantages:

- Fast service
  - Single contact point
  - Sufficient stock
  - In-house knowledge and skills
  - Not dependent on others
- Interfacing with third party systems is developed and maintained internally: think of DP, Pilot and VDR interfaces
  - The Veth Autopilot interface provides the ability to control the thruster asynchronously
  - The DP interface provides safety around the DP control.

## Driven by simplicity

Also for electronics Veth Propulsion believes in simplicity. For ourselves and for you as end user! You can contact us if you want a system that is maintenance and service friendly, and naturally easy to use.

## Latest technology

At Veth Propulsion you choose for a standard modular design. The choices Veth Propulsion makes are based on dynamic

and proven technologies from the automotive industry. Through years of experience with various systems and their users, Veth Propulsion can advise which systems are best suited to your specific needs and situation.

The quality, performance and esthetics of the systems are closely monitored and continuously developed using the latest techniques.

## Characteristics

- User friendly
- Standard with 3 languages (NL, DE, EN), with more languages possible
- Low power consumption by deactivation of the system (Starting the system takes less than two seconds)
- User specific requirements possible
- Touchscreen panel with color display
- Fully dimmable panels (0% - 100%)



Anesha | Wheelhouse

## River cruise vessel with wingpanels

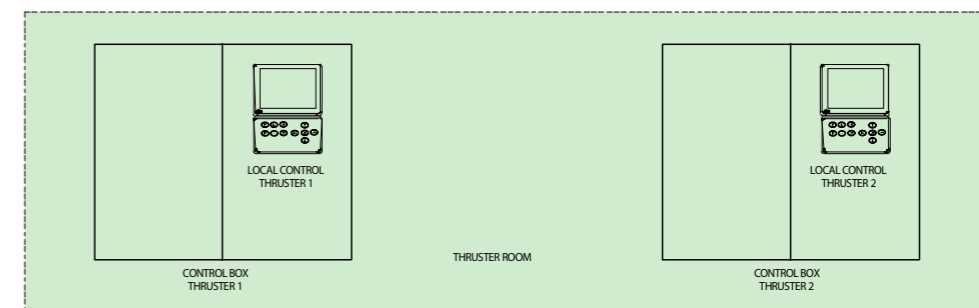
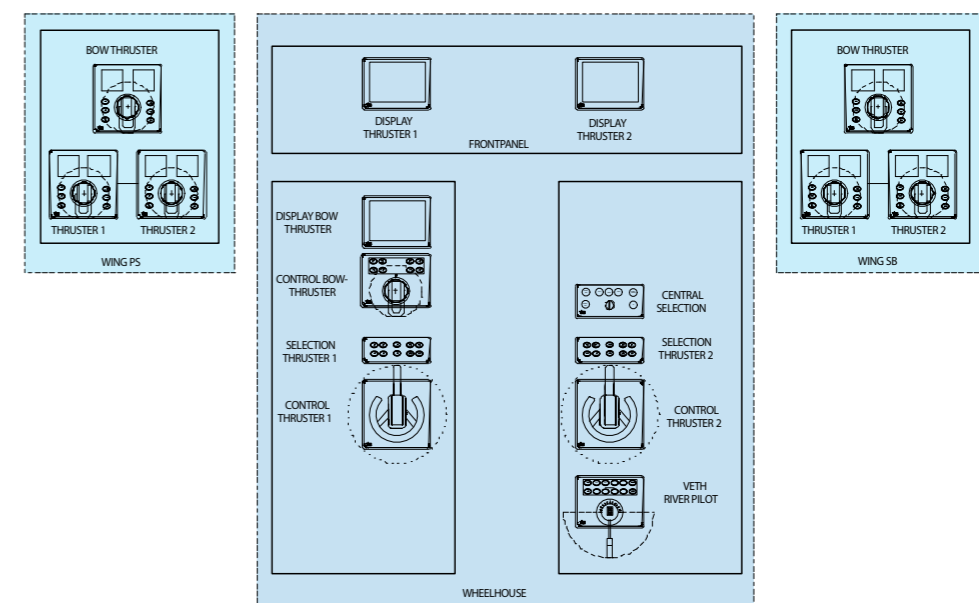
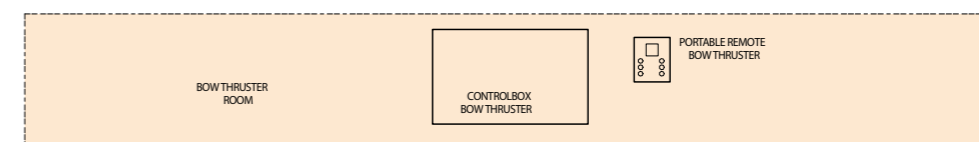

# Double ended ferry double wheelhouse

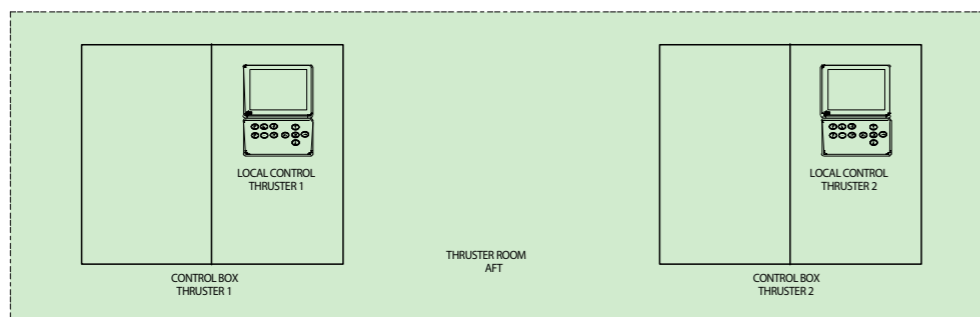
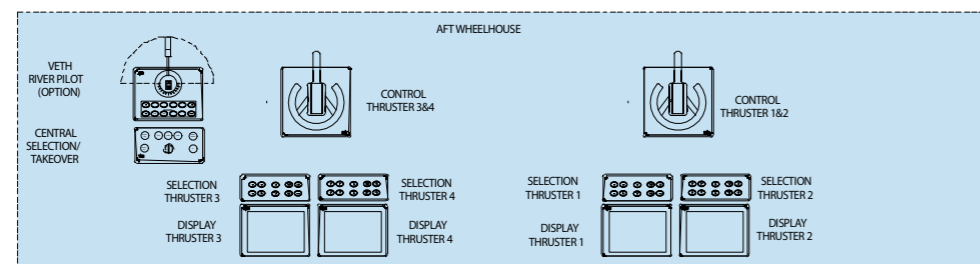
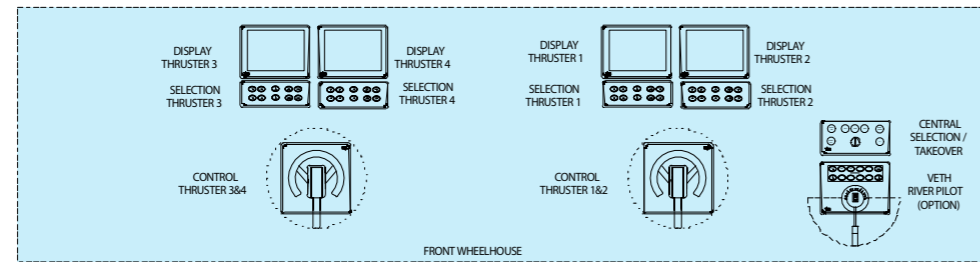
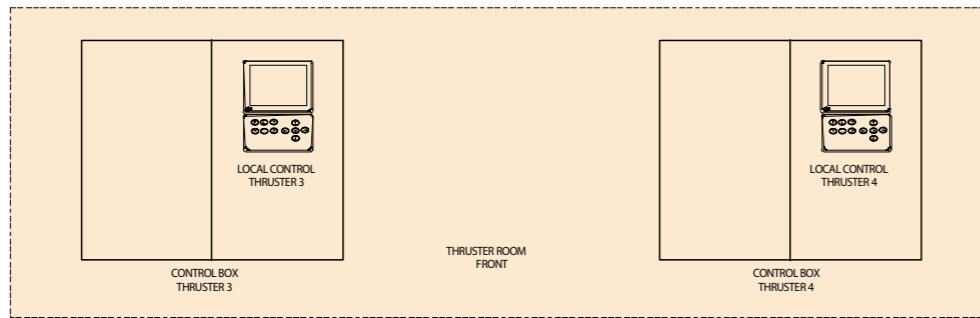

Display thruster



Veth river pilot



Wing panel



Local control

# Tug boat

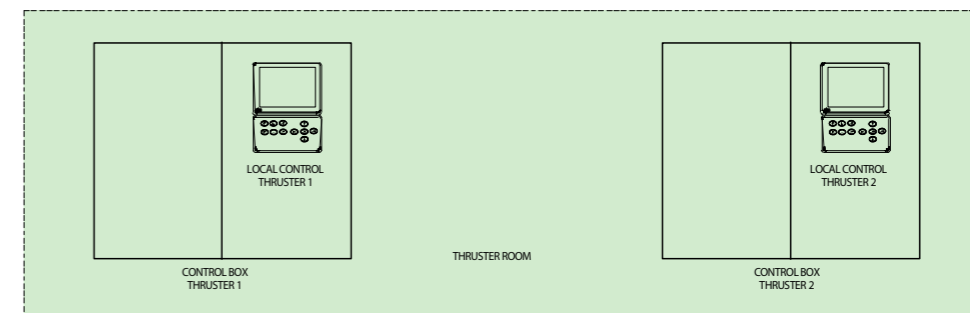
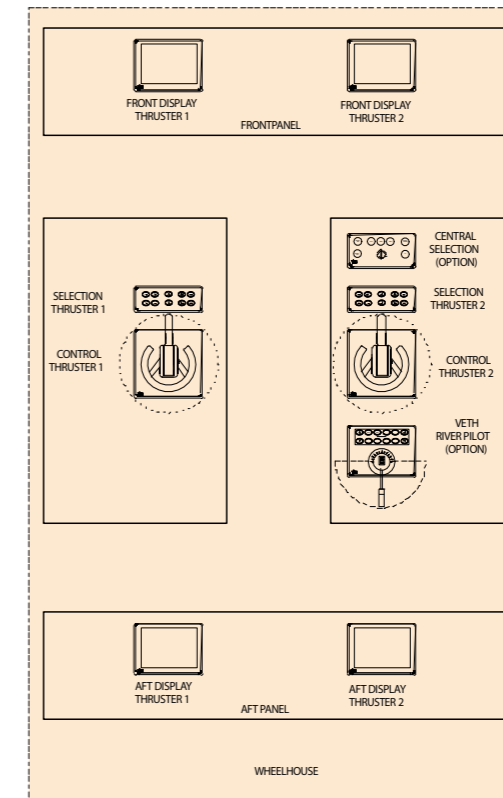

Control thruster



Control thruster



Front display thruster

## Service

The partnership with you does not end when you receive the product. It is just starting... We understand that providing fast and high quality service is essential for you.

Veth Propulsion believes service should be flexible, available, proactive and affordable. As a customer you cannot afford any downtime on equipment. Our goal is to minimise the costs when an unexpected situation arises. We keep a large stock of parts for all thrusters types we have ever built and we are able to supply parts to the furthest regions within days.

As our customer you are entitled to 24/7 accessibility, proactive assistance and optimal access to parts in stock, which means that Veth Propulsion can provide you with quick and effective service. We work closely with sales and service locations worldwide, which is why we can serve you anywhere around the world.



*SasTech focusses on innovations and solutions for Naval Architecture challenges that are not fixed in rules. Veth Propulsion is an innovative and creative company, with decades of practical experience. Together we combine theory with practice to create suitable solutions for different types of vessels and customers.*

Frans Sas, consultant and founder SasTech



Stock warehouse with thruster parts

# Global service network

Veth Propulsion believes in a personal relationship with its clients. A family business, but through our global network of local agents, a global player where borders do not stand in the way of maintaining our personal involvement with you.

For a current list of local service centers worldwide, please check our website.

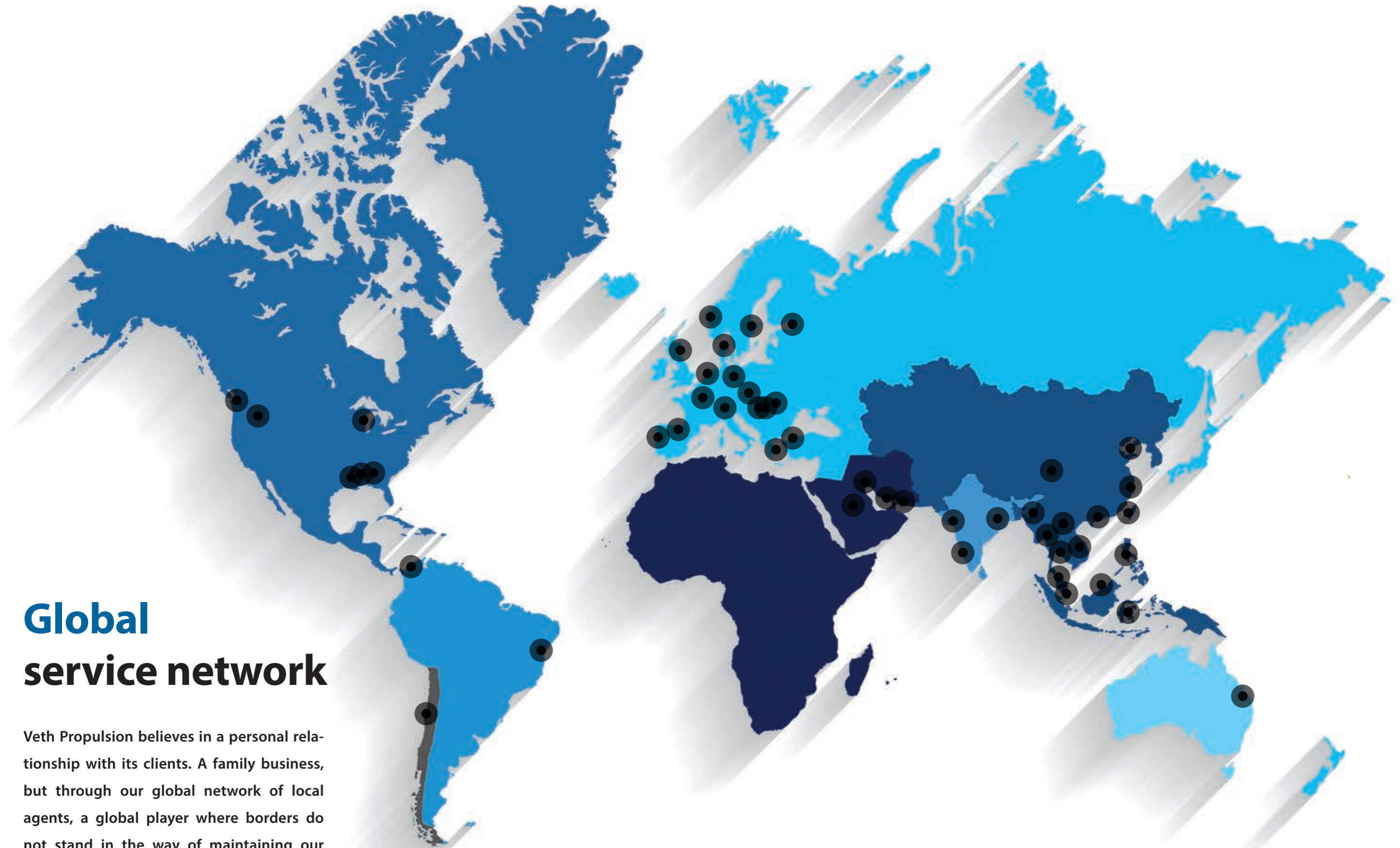

- Sales / Service office
- Nico International
- Napro Service
- Veth Propulsion
- Twin Disc Far East
- Ultimate Marine Power
- Twin Disc / Sewart Supply / Mill Log
- Indostan
- Eurotécnica





Made in Holland



Veth Propulsion  
P.O. Box 53  
3350 AB Papendrecht

**T:** +3178 615 22 66  
**E:** [info@veth.net](mailto:info@veth.net)  
**www.vethpropulsion.com**